

VERDERFLEX[®]

Peristaltic Industrial Tube Pump

Original Operating Manual

Rapide
Rapide S
Rapide 5000

Version 2.1v-10/2020

Print-No. 01



VERDER
passion for pumps



Version 2.1v-10/2020
Print-No. 01

Rapide Rapide S Rapide 5000



The information in this document is essential for the safe operation and servicing of Verderflex® Rapide family of pumps. This document must be read and understood thoroughly prior to installation of unit, electrical connection and commissioning.

Table of Contents

<p>1 About this Document</p> <ul style="list-style-type: none"> 1.1 Target Groups 1.2 Warnings and Symbols Used in the Manual 1.3 Tools used on the Rapide 5000 Pump <p>2 Safety</p> <ul style="list-style-type: none"> 2.1 Intended Use 2.2 General Safety Instructions <ul style="list-style-type: none"> 2.2.1 Product Safety 2.2.2 Obligation of the Operating Company 2.2.3 Obligation of Personnel 2.3 Specific Hazards <ul style="list-style-type: none"> 2.3.1 Hazardous Pumped Liquids 2.3.2 Sharp Edges <p>3 Transport, Storage and Disposal</p> <ul style="list-style-type: none"> 3.1 Transport <ul style="list-style-type: none"> 3.1.1 Unpacking and Inspection on Delivery 3.1.2 Lifting 3.2 Storage Conditions 3.3 Interim Storage After Using the Pump 3.4 Interim Storage Before Using the Pump 3.5 Disposal <p>4 Layout and Function</p> <ul style="list-style-type: none"> 4.1 Design Details 4.2 Labelling <ul style="list-style-type: none"> 4.2.1 Name Plate 4.3 Layout <ul style="list-style-type: none"> 4.3.1 Rapide Exploded View 4.3.2 Rapide 'S' Exploded View 4.3.3 Rapide 5000 Exploded View <p>5 Installation and Connection</p> <ul style="list-style-type: none"> 5.1 Electrical Installation <ul style="list-style-type: none"> 5.1.1 Checking the Ambient Conditions 5.1.2 Installing the Gear Motor Unit (where not supplied) 5.1.3 Connecting to a Power Supply 5.2 Installing the Rapide Pump <ul style="list-style-type: none"> 5.2.1 Installing the Rotor 5.2.2 Installing the Tube 5.3 Installing the Rapide 'S' <ul style="list-style-type: none"> 5.3.1 Installing the Tube 5.3.2 Optional Tube Saddle Status Detection SSD 5.3.3 Adjusting the Tube Clamp 5.3.5 Installing a Multi-Channel Pump Head 5.4 Installing the Rapide 5000 <ul style="list-style-type: none"> 5.4.1 Installing Continuous Tube 5.4.2 Installing the Tube Element 5.4.3 Rotor Assembly Replacement 	<p>6 Operation</p> <ul style="list-style-type: none"> 6.1 Pre-commissioning the Pump <ul style="list-style-type: none"> 6.1.1 Checking the Direction of Rotation with Dry Pump 6.1.2 Starting the Pump 6.1.3 Switching OFF the Pump 6.2 Commissioning the Pump <ul style="list-style-type: none"> 6.2.1 Switching ON the Pump 6.2.2 Switching OFF the Pump (Refer to → 6.1.3) 6.3 Shutting Down the Pump 6.4 Start-up Following a Shutdown Period 6.5 Operating the Stand-by Pump <p>7 Inspection, Maintenance and Repair</p> <ul style="list-style-type: none"> 7.1 Inspection 7.2 Maintenance <ul style="list-style-type: none"> 7.2.1 Cleaning the Pump 7.2.2 Cleaning the Rapide 5000 Pump Head Burst Sensor if Fitted (optional) 7.2.3 Rapide Maintenance Schedule 7.3 Repairs <ul style="list-style-type: none"> 7.3.1 Returning the Pump to the Service Centre 7.4 Ordering Spare Parts <p>8 Troubleshooting</p> <ul style="list-style-type: none"> 8.1 Pump malfunctions <p>9 List of Figures and Tables</p> <ul style="list-style-type: none"> 9.1 List of Figures 9.2 List of Tables <p>10 EC Declaration of Conformity</p> <p>11 Trademarks</p> <p>Appendix A</p> <p>1 Technical Specifications</p> <ul style="list-style-type: none"> 1.1 Pump Specifications – Rapide 1.2 Pump Specifications – Rapide 'S' 1.3 Pump Specifications Rapide 5000 1.4 Tube Options 1.5 Ambient Conditions
--	---

1 About this Document

The Verderflex Rapide range of peristaltic pumps have been developed according to the latest technology and subject to continuous quality control. These operating instructions are intended to facilitate familiarisation with the pump and its designed use. This manual will act as a guide for operating the pump. You are advised to follow these guidelines to operate the pump correctly. These operating instructions do not take local regulations into account; the operator must ensure that such regulations are strictly observed by all, including the personnel responsible for installation.

1.1 Target Groups

Target Groups	Duty
Operating Company	<ul style="list-style-type: none"> ▶ Keep this manual available at the operating site of the pump. ▶ Ensure that personnel read and follow the instructions in this manual and any other applicable documents, especially all safety instructions and warnings. ▶ Observe any additional rules and regulations referring to the system.
Qualified personnel, fitter	<ul style="list-style-type: none"> ▶ Read, observe and follow this manual and the other applicable documents, especially all safety instructions and warnings.

Table 1 Target Groups

1.2 Warnings and Symbols Used in the Manual





Warning	Risk Level	Consequences of disregard
	Immediate risk	Death, serious bodily harm
	Potential acute risk	Death, serious bodily harm
	Potential hazardous situation	Potential damage to the pump
	For information	Possible incorrect use/maintenance of pump

Table 2 Warnings Used in the Manual







Symbol	Meaning
	Safety warning sign in accordance with DIN 4844 - W9 <ul style="list-style-type: none"> ▶ Take note of all information highlighted by the safety warning sign and follow the instructions to avoid injury or death.
	Instruction
	Multiple-step instructions
	Checklist
	Cross-reference
	Information

Table 3 Symbols Used in the Manual

1.3 Tools used on the Rapide 5000 Pump





Tools	Image	Description
Tool for 17mm nut		<ul style="list-style-type: none"> – used to access the hand crank hexagon nut when installing the tube (→ 5.4 Installing the Rapide 5000)
Tool for 17mm nut cover (4mm allen key)		<ul style="list-style-type: none"> – used to undo the shaft guard cover to gain access to the hand crank hexagon nut (→ 5.4 Installing the Rapide 5000)
Unlock Key		<ul style="list-style-type: none"> – used to unlock/open the pump door. <p>NOTE: To activate the 'plunger' lock, press the 'barrel' in by hand. (the key is only required for unlocking) Additional keys are available on request.</p>

Table 4 Tools Used on the Rapide 5000 Pump

2 Safety

 The manufacturer does not accept any liability for damage resulting from disregard of this documentation.

2.1 Intended Use

- ▶ Only use the pump to handle compatible fluids as recommended by the manufacturer (→ Appendix A).
- ▶ Adhere to the operating limits.
- ▶ Consult the manufacturer regarding any other use of the pump.
- ▶ Pumps delivered without a motor must be fitted with a motor in accordance with the provisions of EC Machinery Directive 2006/42/EC.

Prevention of obvious misuse (examples)

- ▶ Note the operating limits of the pump with regard to temperature, pressure, flow rate and motor speed (→ Appendix A).
- ▶ Do not operate the pump with any inlet/outlet valves closed
- ▶ Only install the pump as recommended in this manual. For example, the following are not allowed:
 - Installing the pump without proper support.
 - Installation in the immediate vicinity of extreme hot or cold sources.

2.2 General Safety Instructions

 Observe the following regulations before carrying out any work.

2.2.1 Product Safety

- These operating instructions contain fundamental information which must be complied with during installation, operation and maintenance. Therefore this operating manual must be read and understood both by the installing personnel and the responsible trained personnel / operators prior to installation and commissioning, and it must always be kept easily accessible within the operating premises of the machine.
Not only must the general safety instructions laid down in this chapter on “Safety” be complied with, but also the safety instructions outlined under specific headings.
- Operate the pump only if it and all associated systems are in good functional condition.
- Only use the pump as intended, fully aware of safety and risk factors involved and the instructions in this manual.
- Keep this manual and all other applicable documents complete, legible and accessible to personnel at all times.
- Refrain from any procedure or action that would pose a risk to personnel or third parties.
- In the event of any safety-relevant faults, shut down the pump immediately and have the malfunction corrected by qualified personnel.
- The installation of the pump must comply with the requirements of installation given in this manual and any local, national or regional health and safety regulations.

2.2.2 Obligation of the Operating Company

Safety-conscious operation

- Ensure that the following safety aspects are observed and monitored:
 - Adherence to intended use
 - Statutory or other safety and accident-prevention regulations
 - Safety regulations governing the handling of hazardous substances if applicable
 - Applicable standards and guidelines in the country where the pump is operated
- Make personal protective equipment available pertinent to operation of the pump.

Qualified personnel

- Ensure that all personnel tasked with work on the pump have read and understood this manual and all other applicable documents, including the safety, maintenance and repair information, prior to use or installation of the pump.
- Organize responsibilities, areas of competence and the supervision of personnel.
- Have all work carried out by specialist technicians only.
- Ensure that trainee personnel are under the supervision of specialist technicians at all times when working with the pump.

Safety equipment

Provide the following safety equipment and verify its functionality:

- For hot, cold and moving parts: safety guarding should be provided by the operating company.
- For potential build up of electrostatic charge: ensure appropriate grounding if and when required.

Warranty

The warranty is void if the customer fails to follow any Instruction, Warning or Caution in this document. Verder has made every effort to illustrate and describe the product in this document. Such illustrations and descriptions are however, for the sole purpose of identification and do not express or imply a warranty that the products are merchantable or fit for a particular purpose, or that the products will necessarily conform to the illustration or descriptions.

Obtain the manufacturer's approval prior to carrying out any modifications, repairs or alterations during the warranty period. Only use genuine parts or parts that have been approved by the manufacturer.

For further details regarding warranty, refer to terms and conditions.

2.2.3 Obligation of Personnel



It is imperative that the instructions contained in this manual are complied with by the operating personnel at all times.

- ▶ Pump and associated components:
 - Do not lean or step on them or use as climbing aid
 - Do not use them to support boards, ramps or beams
 - Do not use them as a fixing point for winches or supports
 - Do not de-ice using gas burners or similar tools
- ▶ Do not remove the safety guarding for hot, cold or moving parts during operation.
- ▶ Reinstall the safety equipment on the pump as required by regulations after any repair / maintenance work on the pump.

2.3 Specific Hazards

2.3.1 Hazardous Pumped Liquids

Follow the statutory safety regulations when handling hazardous pumped liquids (e.g. hot, flammable, poisonous or potentially harmful).

Use appropriate Personal Protective Equipment when carrying out any work on the pump.

2.3.2 Sharp Edges

Pump parts, such as the shims and impellers, can be sharp

- Use protective gloves when carrying out any work on the pump

3 Transport, Storage and Disposal

3.1 Transport

 Always transport the pump in a stable position and ensure that the pump is securely attached to the pallet.

3.1.1 Unpacking and Inspection on Delivery

1. Report any transport damage to the manufacturer/distributor immediately.
2. Retain the pallet if any further transport is required.

3.1.2 Lifting



CAUTION

Pump damage caused by lifting

- ▶ Do not lift the pump by the the Pump Head as shown in the following illustration.

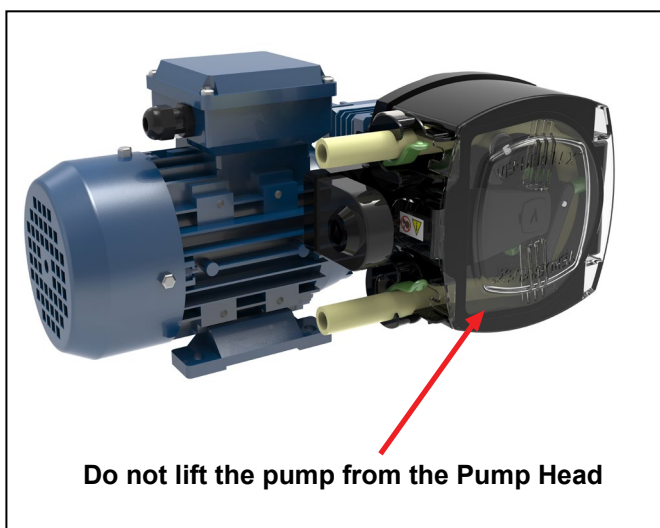

Figure 1 Lifting the Pump (Rapide 5000 shown)

3.2 Storage Conditions

1. Make sure the storage location meets the following conditions:
 - Dry, humidity not to exceed 85%, non-condensing
 - Out of direct sunlight
 - Frost-free; temperature range +10° to +50°C
 - Vibration-free
 - Dust-free
2. Depending on these conditions, it may be advisable to place a moisture-absorbing product, such as Silica gel, inside the pump's housing or to coat the pump's inner surfaces with moisture-repelling oil, such as WD40, whilst the pump is stored.

3. Tubes should be stored as supplied in their wrapper and should be stored away from direct sunlight and at room temperature.
5. Gearboxes may require intermittent attention as indicated by the gearbox manufacturer's recommendations.

3.3 Interim Storage After Using the Pump

- ▶ The tube should be removed from the pump.
- ▶ The pump housing should be washed out, allowed to dry and any external build up of product removed.

3.4 Interim Storage Before Using the Pump



CAUTION

Pump damage caused by interim storage!

- ▶ Allow the pump to reach ambient temperature before use.
- ▶ Please observe the storage recommendations and use by dates which apply to hose you may wish to bring into service after storage.

3.5 Disposal

With prolonged use, pump parts can be contaminated by hazardous pumped liquids to such an extent that cleaning may be insufficient.



WARNING

Risk of poisoning and environmental damage by the pumped liquid or oil!

- ▶ Use suitable personal protective equipment when carrying out any work on the pump.
- ▶ Prior to disposal of the pump:
 - Drain and dispose the lubricant in accordance with local regulations.
 - Collect and dispose of any leaking pumped liquid or oil in accordance with local regulations.
 - Neutralize residues of pumped liquid in the pump.
- ▶ Dispose of the pump and associated parts in accordance with local regulations.

4 Layout and Function

i The medium to be pumped does not come into contact with any moving parts and is totally contained within the tube. A roller passes along the length of the tube, compressing it. This motion forces the contents of the tube directly in front of the roller to move forward along the length of the tube in a 'positive displacement' peristaltic movement. In the wake of the roller's compressing action, the natural elasticity of the tube material causes the tube to recover and regain its round profile. This creates suction pressure which refills the tube.

4.1 Design Details

i The Verderflex Rapide range of tube pumps provide a balanced selection of simple to operate peristaltic pumps. The family offers the customer pump choices that are compact, can have multiple heads, are simple by design, and the Smart series provide rapid tube changeovers.

4.2 Labelling

4.2.1 Name Plate

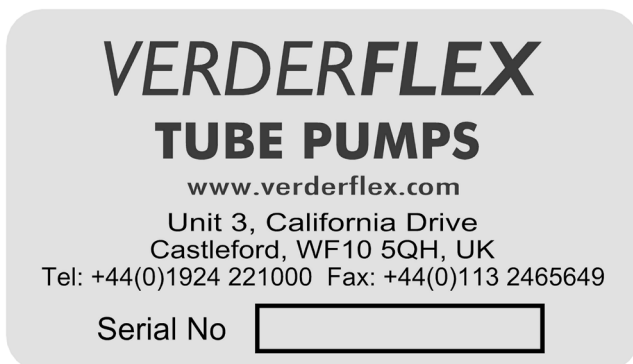

Figure 2 Name Plate

i When requesting spares, the model and serial number should always be quoted.

4.3 Layout

4.3.1 Rapide Exploded View

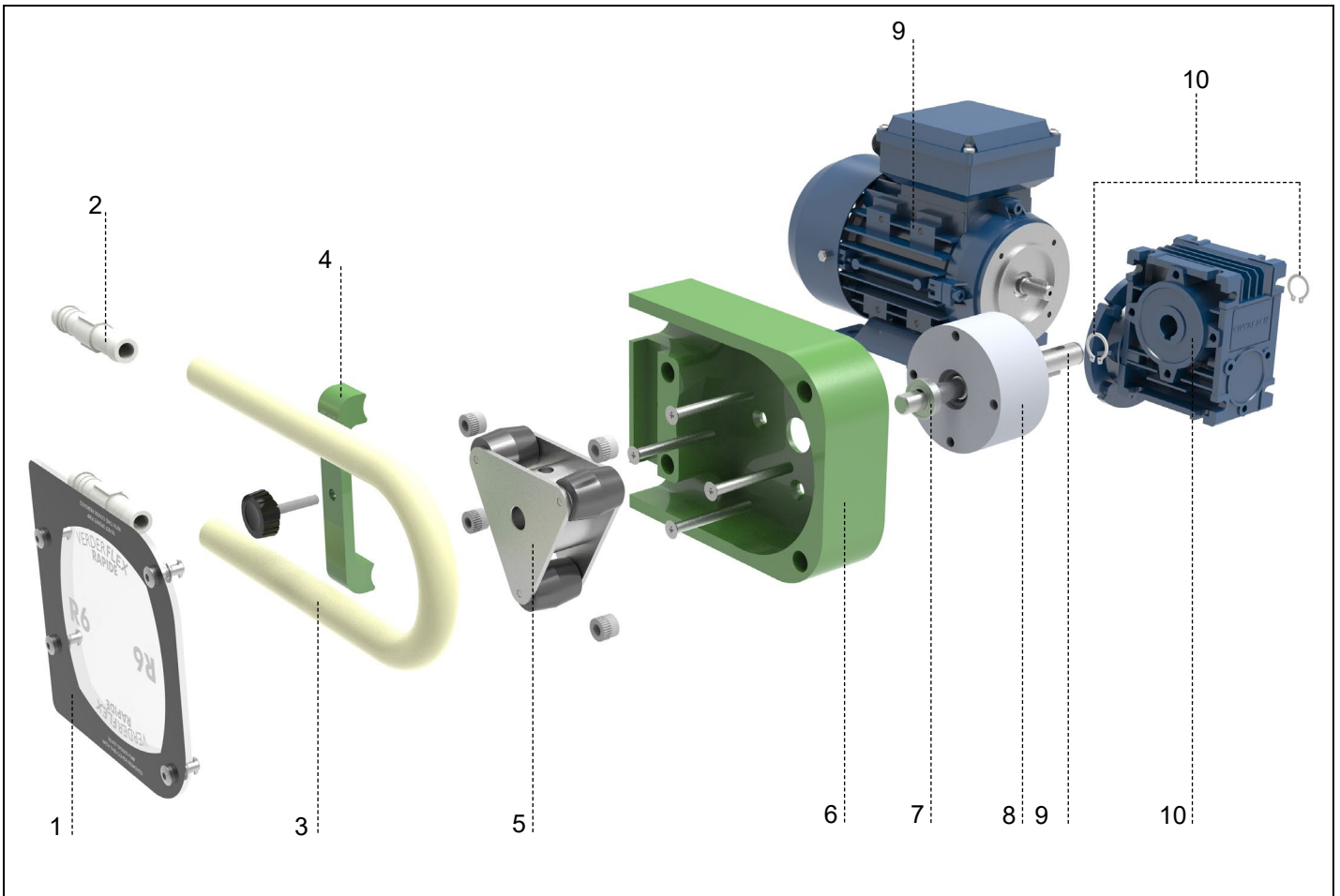

Figure 3 Rapide Exploded View (Generic View)

- | | | | | | |
|---|---------------------|---|----------------|----|-------------------|
| 1 | Front Cover | 5 | Rotor Assembly | 9 | Drive Shaft |
| 2 | Connectors | 6 | Pump Body | 10 | External Cir-Clip |
| 3 | Tube Element | 7 | Bearing | 11 | Gearbox |
| 4 | Tube Clamp Assembly | 8 | Adaptor Sleeve | 12 | Motor |

4.3.2 Rapide 'S' Exploded View

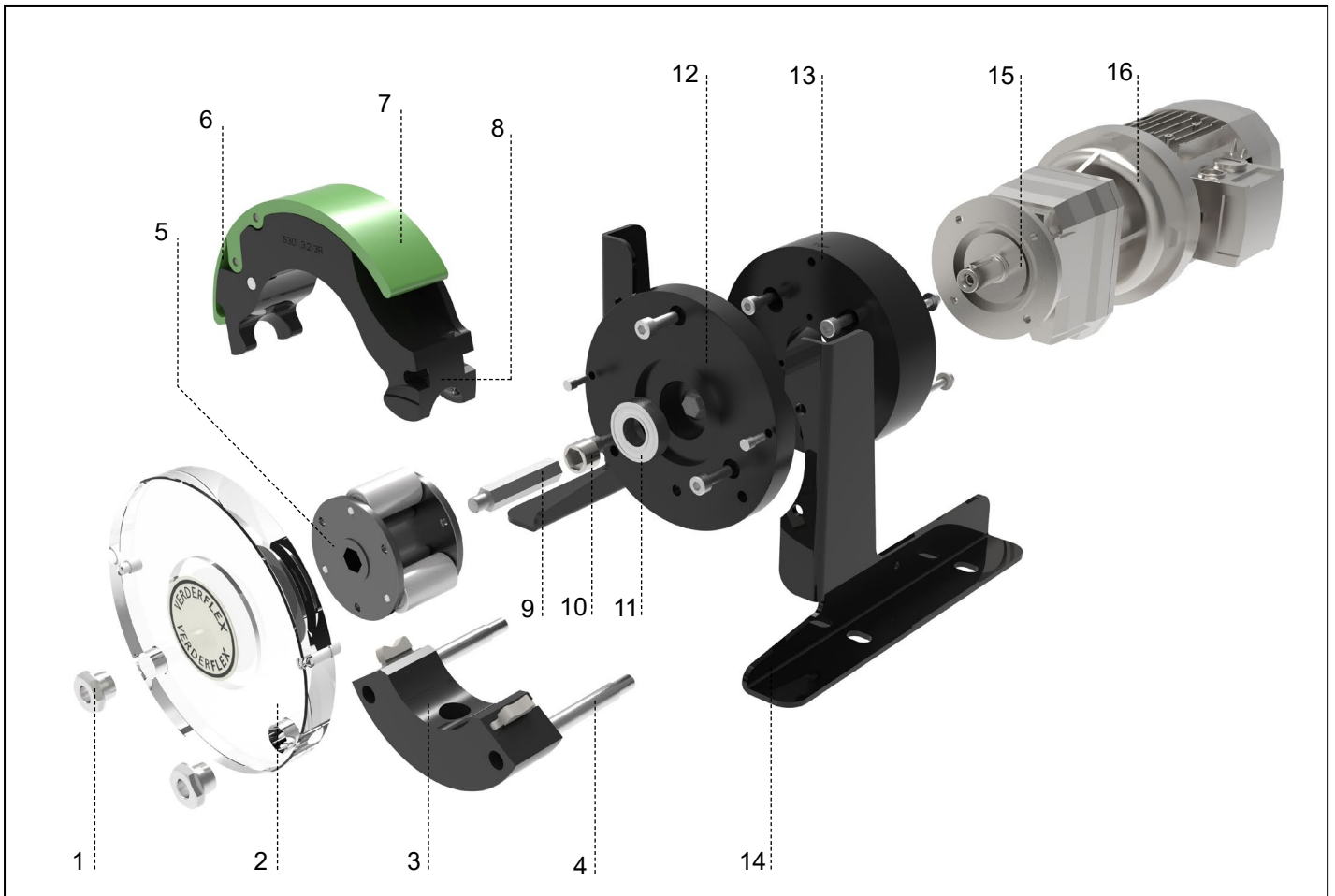

Figure 4 Rapide 'S' Exploded View (Generic View)

1	Locking Nuts	5	Roller and Rotor Assembly	9	Drive Shaft	13	Mounting Flange
2	Front Cover	6	Ski Boot Catch	10	Drive Coupling Bush	14	Frames
3	Clamping Assembly	7	Ski Boot Handle	11	Bearing	15	Gearbox
4	Tie Bar	8	Saddle	12	Back Plate	16	Motor

4.3.3 Rapide 5000 Exploded View

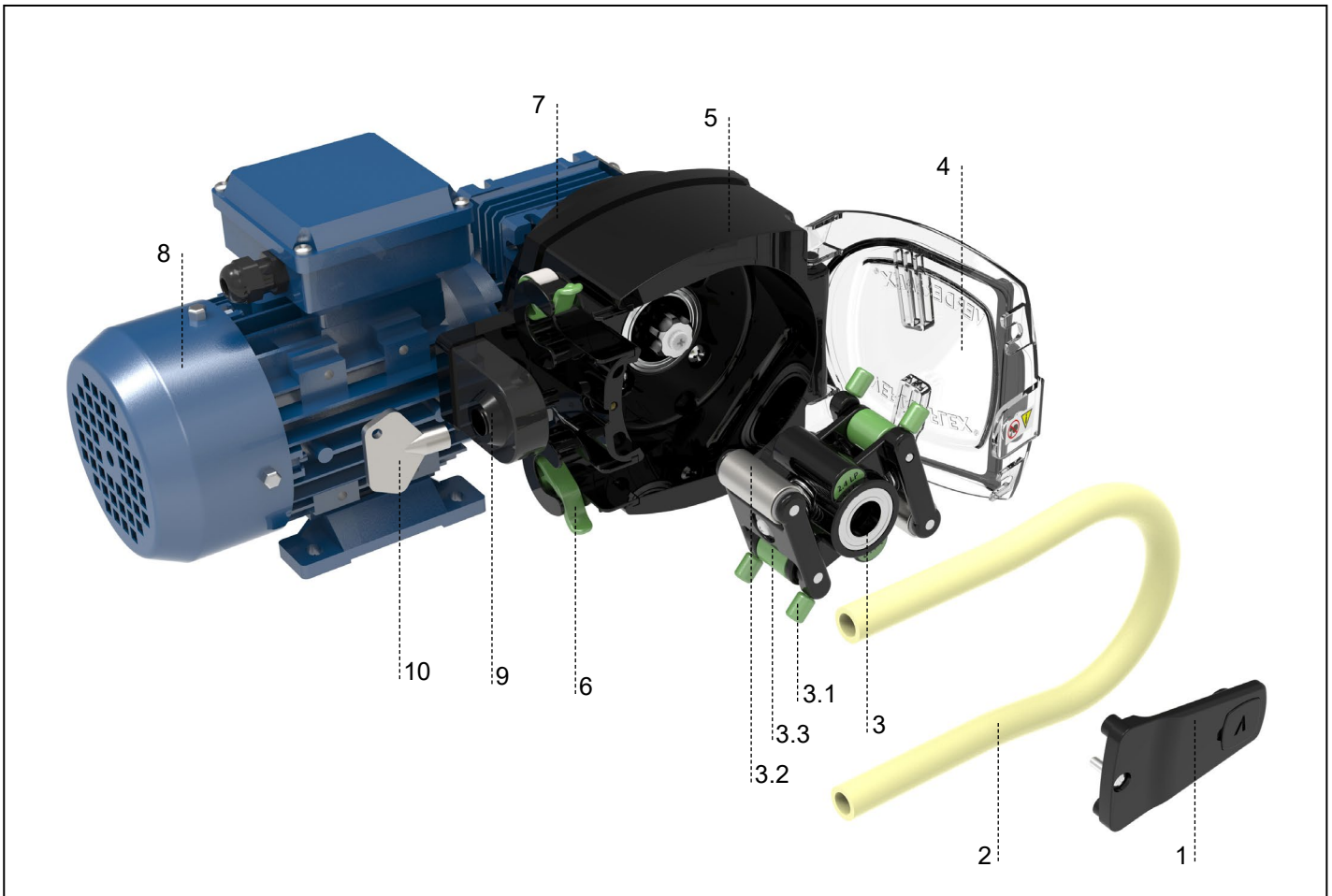

Figure 5 Rapide 5000 Exploded View (Generic View)

- | | | | | | |
|-----|------------------------|-----|--------------------------|---|-------------------|
| 1 | Bearing Strut | 3.2 | Main Rollers | 6 | Tube Clamp |
| 2 | Continuous Tube | 3.3 | Horizontal Guide Rollers | 7 | Motor Gearbox |
| 3 | Rotor Assembly | 4 | Pump Door | 8 | Motor |
| 3.1 | Vertical Guide Rollers | 5 | Pump Head | 9 | Key Operated Lock |
| 10 | Unlock Key | | | | |

Note

The lock key (item 10) is used to unlock/open the pump door.
The lock (item 9) is activated by pushing the lock 'barrel' in by hand.

5 Installation and Connection



CAUTION

Material damage due to unauthorized modification on pump

- ▶ Unauthorized modification will invalidate the warranty.

5.1 Electrical Installation



CAUTION

Failure to follow safe and proper electrical installation practices may result in pump malfunction or dangerous operation

- ▶ Make sure the pump is installed correctly.
- ▶ The pump is supplied with a pre-fitted main lead which is not a user-replaceable part.
- ▶ The mains lead may have a fuse fitted (country dependant)
- ▶ The fuse should be replaced with an identical fuse in the event of the fuse blowing.

5.1.1 Checking the Ambient Conditions

1. Make sure that the operating conditions are corrected. (→ *Appendix A*)
2. Make sure the required ambient conditions are fulfilled. (→ *Appendix A*)

5.1.2 Installing the Gear Motor Unit for Rapide and Rapide 'S' (where not supplied)

1. Lift motor and gearbox using suitable lifting gear.
2. Apply anti seize grease to the gearbox shaft.
3. Offer gearbox shaft up to the adaptor sleeve.
4. Align key to the key way.
5. Connect motor to the rated power supply. Ensure the correct gland is used and that the earth connection is made and secured.
6. Run the pump to ensure correct direction of rotation.

5.1.3 Connecting to a Power Supply



DANGER

Risk of electrocution!

- ▶ All electrical work must be carried out by qualified electricians.
- ▶ Make sure that the electrical information on the rating plate agrees with the power supply.
- ▶ Isolate the main supply before replacing the tube/cartridge
- ▶ Isolate the main electrical supply before opening the pump head/cover.

Checklist:

- Pump set up and connected properly.
- Motor set up and connected properly.
- All connections stress-free and sealed.
- All safety equipment installed and tested for functionality.

5.2 Installing the Rapide Pump

! DANGER

- ▶ Isolate power supply from the pump before opening the pump head.

5.2.1 Installing the Rotor

1. Align grub screw hole with flat on shaft.
2. Align peak of roller with peak of tube track or set rotor distance back from front of pump housing as indicated (→ Figure 6 Installing the Rotor).
3. Fasten grub screw securely.

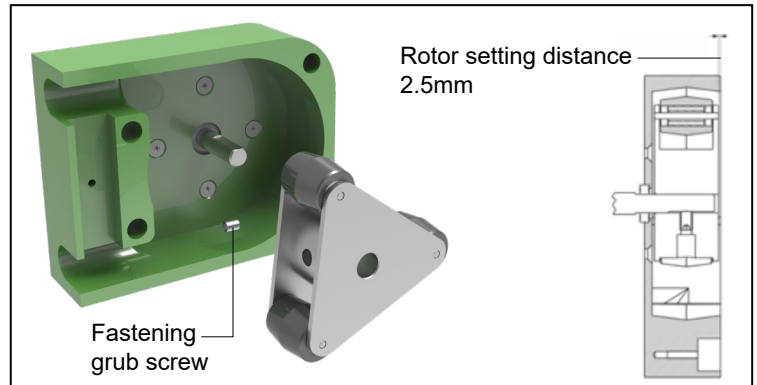

Figure 6 Installing the Rotor - Rapide Pump

5.2.2 Installing the Tube

1. Remove the clamp, but leave the front cover in place.
2. Run the pump at low speed and carefully feed tube through the inlet.
3. When tube reaches outlet, use blunt end rod to guide the tube out.
4. Fit tube clamp loosely, and position tube with marked lines adjacent to edge of pump housing and tube clamp.
5. Tighten the tube clamp securely.

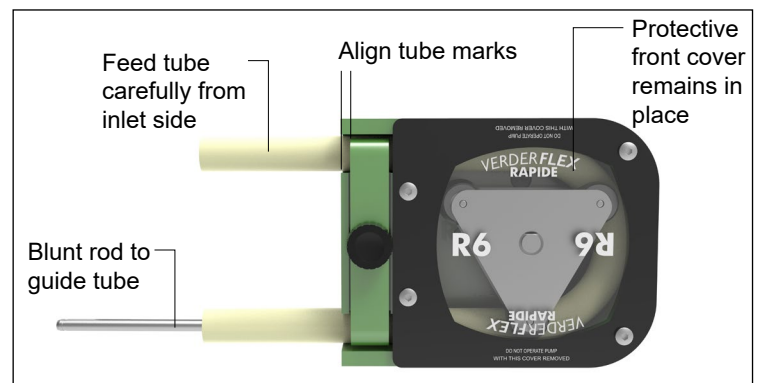

Figure 7 Installing the Tube - Rapide Pump

5.3 Installing the Rapide 'S'

i The Rapide 'S' pump head comprises four main parts:

- ▶ The rotor with rollers which are responsible for the peristaltic action of the pump.
- ▶ The transparent front cover, which allows the operator to check the pump operation and the direction of rotation.
- ▶ The lower section, which houses the U-shaped tube clamps. The tube clamps are adjusted, for any permitted tube size, by means of a screw driver slot or the thumb-screws, which are located in the underside/side of the clamp base. The purpose of the clamps is to stop the tube from 'walking' to the discharge side. On the pressure side, the clamps are designed to self-centre the tube.
- ▶ The tube saddle counteracts the compressive action of the rotor. The saddle can be removed by unlocking the 'ski-boot' style lever.

5.3.1 Installing the Tube

1. Insert tube on top of the rollers.
2. Fit the saddle to one set of dowels.
3. Open up the ski boot handle and fit the catch over the saddle.
4. Push the handle down to lock the saddle into place over the other set of dowels.

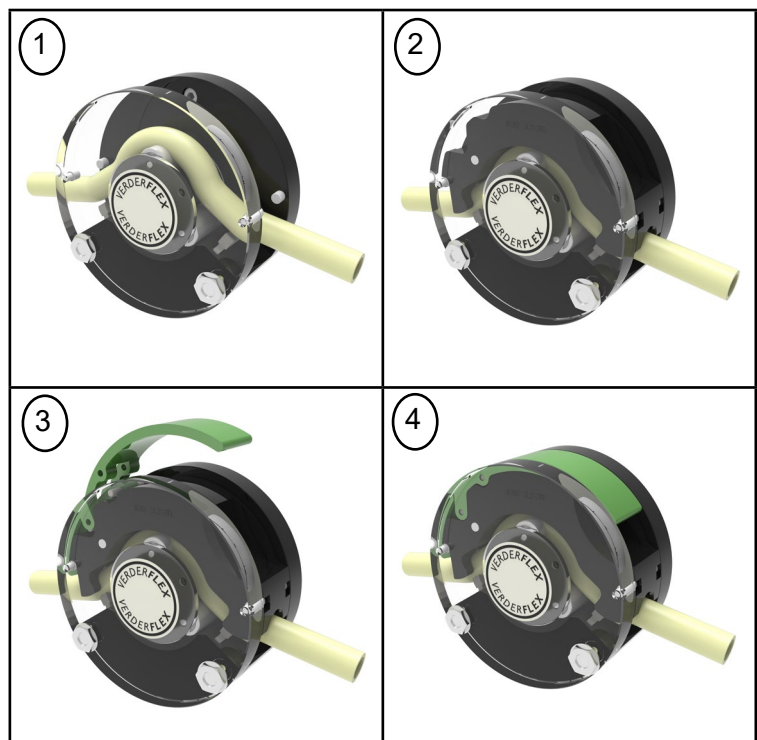



Figure 8 Installing the Tube - Rapide 'S' Pump

5.3.2 Optional Tube Saddle Status Detection SSD

 The tube saddle status detection interlocks the tube saddle and the pump. The tube saddle status detection comprises two main components:

- ▶ A reed switch embedded in the back plate of the pump head
- ▶ A set of two magnets fitted to the tube saddle, one at either side. This means that it does not matter, which way round the saddle is fitted to the pump head.

When connected, the tube saddle status detection can detect if the tube saddle is fitted properly and can either:

- Not allow the pump to be started or,
- Stop the pump immediately if the saddle is opened while the pump is running.

5.3.3 Adjusting the Tube Clamp

 To insert the tube clamps, unscrew thumb-screw fully into tube clamp and slide into clamp base, unscrew thumb-screw sufficiently to insert clamp block over thumb-screw flange and into clamp base.

Take care that the tube clamp is inserted the correct way round, i.e. centre line of tube recess is in the centre of the clamp base. If this is not done the tube clamp will hit the tube saddle.

Tube Clamp Tensioning Screws

1. Use a flat bladed screw driver to rotate the recessed screws, this will tension or slacken off the tube clamps respectively. Alternately adjust the thumb screw to adjust the clamps.
2. Rotate until tube is adequately tightened and tube walk is eliminated.

5.3.5 Installing a Multi-Channel Pump Head

Installing a multi-channel pump head is very similar to the procedure of fixing a standard pump head. However, please note:

- ▶ Each channel is fitted with its own saddle status detector. The wires should be threaded through the horizontal bore of each lower pump head section, pointing towards the pump casing.
- ▶ Behind the back plate, which is bolted to the pump casing, connect the wires in series to the cable leading to the safety board.
- ▶ Finally stack up the individual components on the tie bars and drive shaft to assemble the multi pump head.

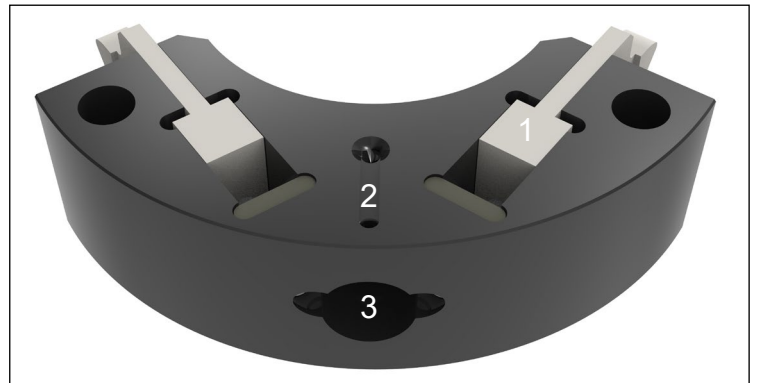

Figure 9 Tube Clamp Tensioning Screw

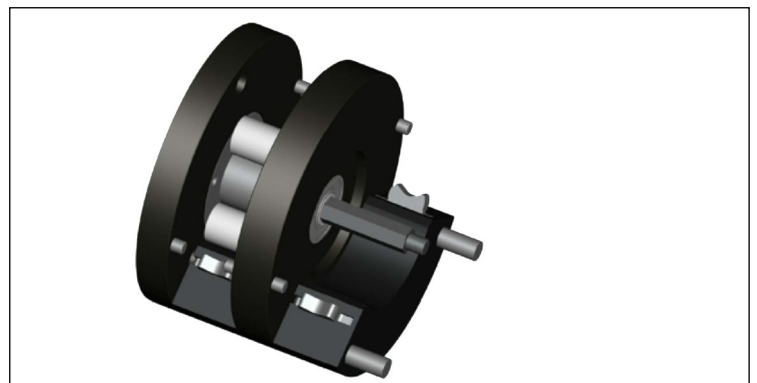

Figure 10 Installing a Multi-Channel Pump Head

5.4 Installing the Rapide 5000

5.4.1 Installing Continuous Tube

⚠ DANGER

- ▶ Isolate the pump from the main power supply before opening the pump door or performing any positioning, removal or maintenance operation.

⚠ CAUTION

- ▶ Make sure the tube is compatible with the rotor assembly.
- ▶ Before using a new tube assembly, make sure the pump is run in the clockwise direction for 1 minute.

1. Open the pump door and push down the tube (green) clamp.
2. Insert the tube.
3. Undo the shaft guard cover to gain access to the hand crank hexagon nut by using a 17mm across flats socket. Rotate the rotor assembly in a clockwise direction. (single head pump)
4. Place the tube behind the vertical guide rollers and continue to turn the hand crank hexagon nut so that the rotor assembly turns in a clockwise direction. (single head pump)
5. When performed correctly the main rollers will compress the tube and 'draw' it into the pump head and eventually exits the lower area of the head.
6. Release the tube clamp to lock the tube.
7. Push up the lower tube clamp and insert the tube.
8. Once the tube is in place, close the pump door and push in the plunger lock before switching on the power supply.

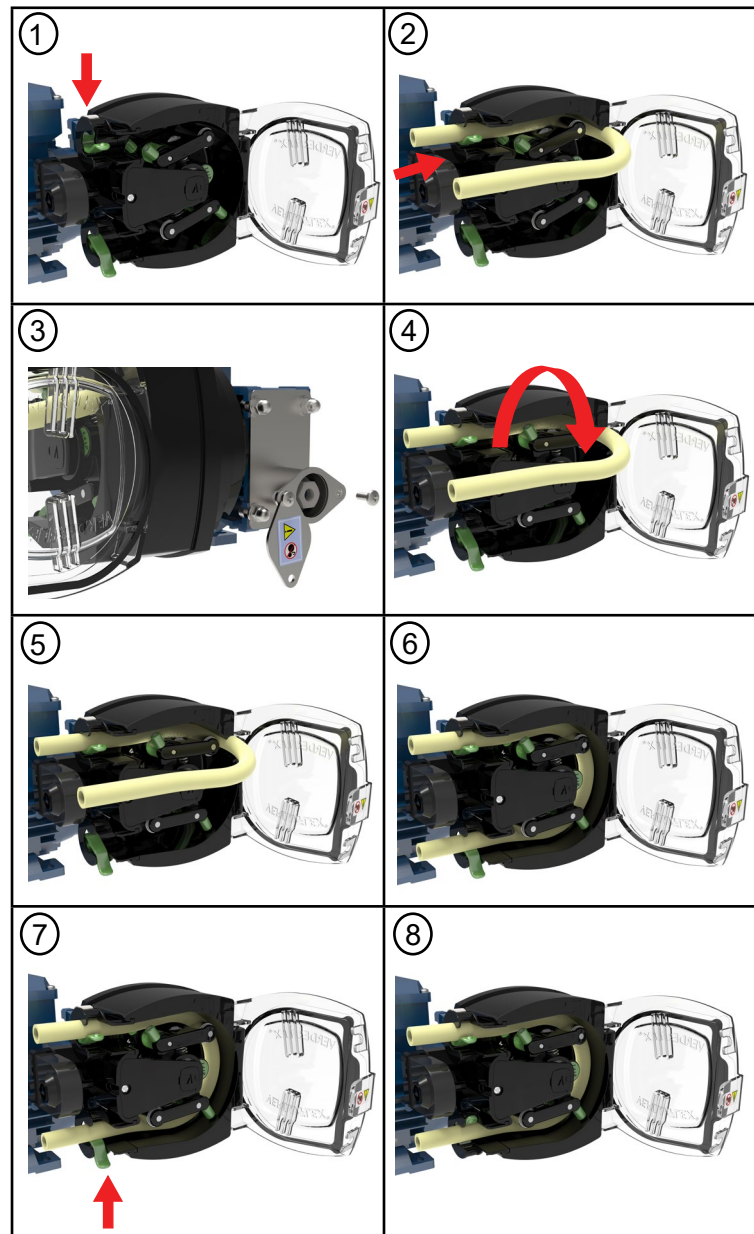

Figure 11 Installing Continuous Tube - Rapide 5000

5.4.2 Installing the Tube Element

⚠ DANGER

- ▶ Isolate the pump from the main power supply before opening the pump door or performing any positioning, removal or maintenance operation.

⚠ CAUTION

- ▶ Make sure the tube is compatible with the rotor assembly.
- ▶ Before using a new tube assembly, make sure the pump is run in the clockwise direction for 1 minute.

1. Open the pump door.
2. Slide the tube element housing into the pump head.
3. Undo the shaft guard cover to gain access to the hand crank hexagon nut by using a 17mm across flats socket. Rotate the rotor assembly in a clockwise direction. (single head pump)
4. Place the tube behind the vertical guide rollers and continue to turn the hand crank hexagon nut so that the rotor assembly turns in a clockwise direction. (single head pump)
5. When performed correctly the main rollers will compress the tube element.
6. Slide the lower tube element housing into the pump head.
7. Once the tube is in place, close the pump door and push in the plunger lock before switching on the power supply.

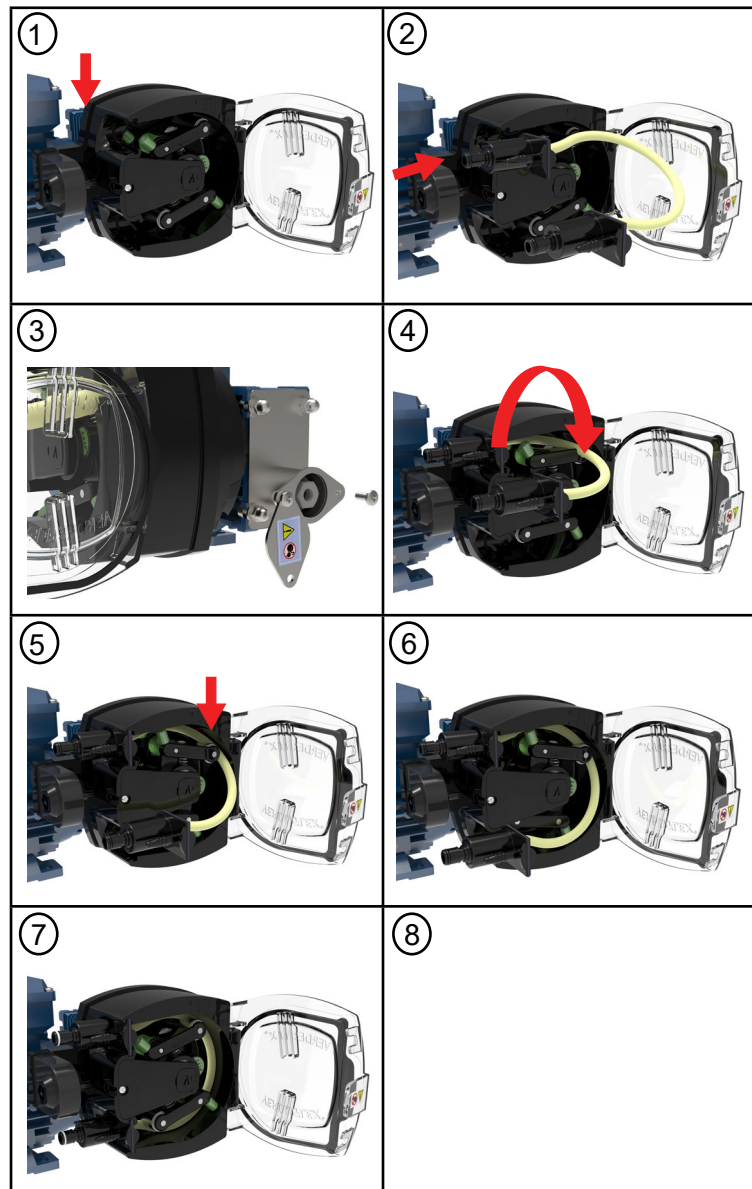

Figure 12 Installing the Tube Element - Rapide 5000

5.4.3 Rotor Assembly Replacement

⚠ DANGER

- ▶ Isolate the pump from the main power supply before opening the pump door or performing any positioning, removal or maintenance operation.

Note

Before removing the rotor assembly, make sure the tube has been correctly removed. (→ 5.4.1 Installing Continuous Tube)

1. Unscrew the M4 bearing strut retaining screw using a screwdriver. (No.2 posidrive)
2. Remove the bearing strut.
3. Remove the rotor assembly by hand.

Note

This may take some effort due to assembly fit.

4. Bearing strut and rotor assembly have been removed.
5. Push replacement rotor into rear pump head bearing.

Note

Ensure the rotor assembly is fully pressed in.

6. Replace the bearing strut and tighten the retaining screw.

Note

The tightening torque value for the retaining screw is 1.5 Nm.

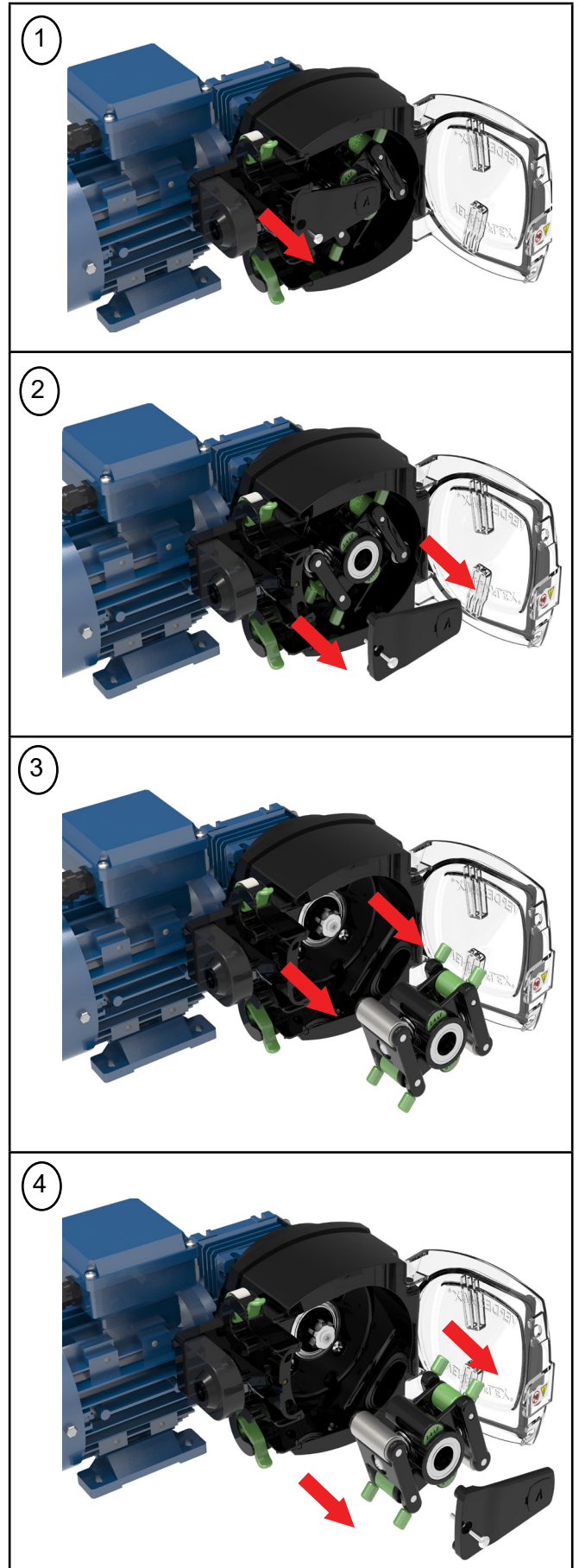

Figure 13 Rotor Assembly Replacement - Rapide 5000

6 Operation

6.1 Pre-commissioning the Pump

6.1.1 Checking the Direction of Rotation with Dry Pump

- Switch the motor on and check the direction of rotation; switch immediately off again.
- If the direction of rotation is different: swap two of the phases (*check with electrician)

6.1.2 Starting the Pump

DANGER

Risk of injury and poisoning due to pumped liquid spraying out!

- ▶ Use personal protective equipment when carrying out any work on the pump.

Equipment damage due to excess pressure

- ▶ Do not operate the pump with the discharge-side fitting closed.
- ▶ Operate the pump only inside the tolerances specified by the manufacturer (→ Appendix A).

WARNING

Risk of injury and poisoning due to hazardous pumped liquids!

- ▶ Safely collect any leaking pumped liquid and dispose of it in accordance with environmental rules and requirements.

Checklist:

- Pump set up and connected properly.
 - Motor set up and connected properly.
 - All connections stress-free and sealed.
 - All safety equipment installed and tested for functionality.
1. Close all drainage taps.
 2. Open the suction-side and the discharge-side fittings.
 3. Switch ON the motor and make sure it is running smoothly.
 4. Run the pump, flushing with water first (cold commissioning) to check for leaks.
 5. Verify that neither the pump nor the pipe connections are leaking.
 6. Perform a second flush by running the pump, 10–20 revolutions with pumped liquid, to remove residue and water inside the pump.

6.1.3 Switching OFF the Pump

WARNING

Risk of injury due to hot pump parts!

- ▶ Use personal protective equipment when carrying out any work on the pump.

NOTE

Risk of dead heading and hose burst due to closed suction or discharge!

- ▶ Keep the suction and discharge side fittings opened till the rotor has come to a complete stop.

Equipment damage due to sediments

- ▶ If the pumped liquid crystallizes, polymerizes or solidifies:
 - Flush pump
 - Make sure that the flushing liquid is compatible with the pumped liquid.

1. If necessary: Flush and empty the pump.
2. Switch off power to the motor.
3. Close the discharge side fitting.
4. Check all tie bolts and tighten them if necessary (only after putting the pump into service for the first time).

6.2 Commissioning the Pump

6.2.1 Switching ON the Pump

! DANGER

Risk of injury due to running pump!

- ▶ Do not touch the moving parts of a running pump.
- ▶ Do not carry out any repair/ maintenance work on the running pump.
- ▶ Allow the pump to cool down completely before starting any work on the unit.

Risk of injury and poisoning due to pumped liquid spraying out!

- ▶ Use personal protective equipment when carrying out any work on the pump.

NOTE

Risk of pulsation when throttling down the suction flow rate!

- ▶ Fully open the suction-side fitting and **DO NOT** use it to adjust the flow as this could damage the hose.

Checklist:

- Pump pre-commissioned. (→ 6.1 Pre-commissioning the Pump)
 - Pump prepared and filled.
1. Open the suction-side and the discharge-side fittings.
 2. Switch on the motor and make sure it is running smoothly.

6.2.2 Switching OFF the Pump (Refer to → 6.1.3)

! WARNING

Risk of injury due to hot pump parts!

- ▶ Use personal protective equipment when carrying out any work on the pump.

NOTE

Damage to tube due to sediments!

- ▶ If the pumped liquid crystallizes, polymerizes or solidifies
 - Flush the tube
 - Make sure that the flushing liquid is compatible with the pumped liquid.

6.3 Shutting Down the Pump

- ▶ Take the following measures whenever the pump is shut down:

Pump is...	Measure
shut down	▶ Take measures according to the pumped liquid (→ Table 6 Measures depending on the behaviour of the pumped liquid).
...dismounted	▶ Isolate the motor from its power supply and secure it against unauthorized switch-on.
...put into storage	▶ Follow the storage instructions (→ 3.2 Storage Conditions)

Table 5 Measures to be Taken if the Pump is Shut Down

Behaviour of the Pumped Liquid	Duration of Shutdown (Depending on Process)	
	Short	Long
Crystallized or polymerized, solids sedimenting	▶ Flush the pump	▶ Flush the pump, remove the hose
Solidifying non-corrosive	▶ Heat up or empty the pump	▶ Empty the pump
Solidifying corrosive	▶ Heat up or empty the pump	▶ Empty the pump ▶ Treat the pump with preservative
Liquid, non-corrosive	-	-
Liquid, corrosive	▶ Empty the pump	▶ Empty the pump ▶ Treat the pump with preservative

Table 6 Measures Depending on the Behaviour of the Pumped Liquid

6.4 Start-up Following a Shutdown Period

1. After a prolonged shutdown period, re-commission the pump as follows:
 - Replace the seals.
 - Install or change tube (→ 5.2.2, 5.3.1, 5.4.1, 5.4.2).
2. Carry out all steps as for the initial start-up (→ 6.1 Pre-commissioning the Pump).

6.5 Operating the Stand-by Pump

Checklist:

- ▶ Operate the stand-by pump at least once a week to avoid formation of permanent dents/setting on the hose.

7 Inspection, Maintenance and Repairs

i Only trained service technicians should be employed for fitting and repair work. Present a pumped medium certificate (DIN safety data sheet or safety certificate) when requesting service.

! DANGER

Risk of injury due to running pump!

- ▶ Do not carry out any repair/maintenance work on a pump in operation.
- ▶ Follow the safety procedures for handling the product being pumped. If the tube has ruptured, the pump head and rotor assembly may be contaminated and/or the pump head may be pressurized.
- ▶ Decontaminate before handling as per local safety regulations.
- ▶ Appropriate measures must be taken to relieve any pressure build up.

Risk of electrocution!

- ▶ Have all electrical work carried out only by qualified electricians.

7.1 Inspections

i The inspection intervals depend on the pump operating cycle.

1. Check at appropriate intervals:
 - Normal operating conditions unchanged
2. For trouble-free operation, always ensure the following:
 - No leaks
 - No unusual running noises or vibrations
 - Tube in position

7.2 Maintenance

i These pumps are generally maintenance free and any work should normally be limited to periodic inspections and cleaning; these may be more frequent in dusty, humid and/or hot conditions.

The pump motor is lubricated for life and should not require attention. Rotor assembly components will wear and may need replacing. Pump tubing will not last forever; establish suitable tube replacement schedule to prevent inconvenient tube failure.

The Rapide 5000 contains no user serviceable parts and is factory sealed to confirm integrity. Pump warranty will be invalidated if the seal is broken.

7.2.1 Cleaning the Pump

NOTE

High water pressure or spray water can damage motors!

- ▶ Do not clean motors with water or steam jet.
 1. Clean large-scale grime from the pump head.
 2. Rinse the tube carefully to remove chemicals.

7.2.2 Cleaning the Rapide 5000 Pump Head Burst Sensor if Fitted (optional)

1. Clean the tube burst detector whenever a tube is being replaced.

! CAUTION

Always clean the sensor after a burst has occurred!

Tube burst detector is an optical sensor used for detecting fluid in the tube chamber and requires periodic cleaning.

2. Clean contaminants from the pump head.
3. Clean the tube carefully to remove chemicals.
4. Clean the sensor surface area and the inner rim of the pump head chamber.

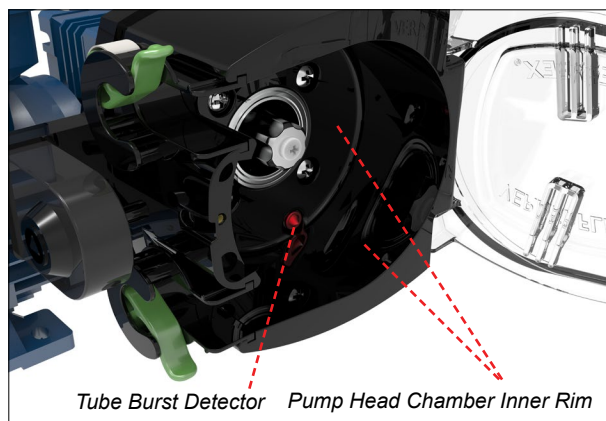

Figure 14 Tube Burst Detector - Rapide 5000

5. Recommended Cleaning Procedure

Gently wipe the screen, pump housing and pump head with a 70% IPA (Isopropanol / Propan-2-ol) solution applied on a clean lint free cloth and allow to evaporate in a well-ventilated area. Accumulated dirt may require more than one application to remove.

7.2.3 Rapide Maintenance Schedule

Task	Frequency	Action
Check pump and gearbox for leaks and damage	<ul style="list-style-type: none"> - Before pump start up - Daily visual inspection - Scheduled intervals during operation 	<ul style="list-style-type: none"> ▶ Repair leaks and damage before operating the pump ▶ Replace components as necessary. ▶ Clean up any spillage.
Check pump gearbox lubrication level	<ul style="list-style-type: none"> - Before pump start up - Daily visual inspection - Scheduled intervals during operation 	<ul style="list-style-type: none"> ▶ → Gear motor instruction manual.
Check pump for unusual temperatures or noise in operation	<ul style="list-style-type: none"> - Daily visual inspection - Scheduled intervals during operation 	<ul style="list-style-type: none"> ▶ Check pump, gearbox and bearing housing for damage. ▶ Replace worn components.
Replace tube element	<ul style="list-style-type: none"> - After inspection when required - When flow has dropped by 25% of nominal value - When the tube is burst/damaged 	<ul style="list-style-type: none"> ▶ Replace hose tube (→ 5.2.2, 5.3.1, 5.4.1 & 5.4.2 Tube change) ▶ If fitted, clean the surface of the tube burst sensor. (→ Figure 14 Tube Burst Detector)
Check pump housing/head and rotor internally	<ul style="list-style-type: none"> - Annually - On replacing the hose 	<p>Worn and damaged surfaces give rise to premature hose failure</p> <ul style="list-style-type: none"> ▶ Replace worn components. ▶ Check bearing play and function.

Table 7 Rapide Maintenance Schedule

7.3 Repairs

There are no user serviceable parts inside the pump.
Repairs can only be carried out by the manufacturer or authorised service centre.

7.3.1 Returning the Pump to the Service Centre

- ▶ Completely emptied and decontaminated.
- ▶ Pump cooled down.
- ▶ Tube removed.

Obtain prior authorisation and returns advice number (for tracking purposes) before return of the pump.

- ▶ Enclose a completed return of goods form when returning pumps or components to the manufacturer.

7.4 Ordering Spare Parts

 For trouble free replacement in the event of faults, we recommend keeping spare parts available on site.

The following information is mandatory when ordering spare parts (→ Name plate):

- Pump model
- Year of manufacture
- Part number / Description of part required
- Serial number
- Quantity

8 Troubleshooting

8.1 Pump Malfunctions

If malfunctions occur which are not specified in the following table or cannot be traced back to the specified causes, please consult the manufacturer.

Possible malfunctions are identified and respective cause and remedy are listed in the table.

Rapide and Rapide 'S' Pump Troubleshooting List:

Problem	Cause	Solution
Low Flow / low discharge pressure	Ratio of inner diameter / wall thickness too large for the application (tube too 'soft')	Use thicker wall thickness tube, if possible, with the same inner diameter. This may require a different saddle or pump.
		Run Pump slower with larger inner diameter tube.
		Check pipework dimensions and layout - revise as required e.g. eliminate small radius bends close the pump's suction connection.
	Viscosity too high	Use a bigger wall thickness tube, if possible, or run the pump slower.
	Suction lift too high, resulting in tube not fully returning to fully round	Use thicker wall thickness tube with the same inner diameter. This may require a different saddle or pump.
		Check pipework dimensions and layout - revise as required.
Use a bigger pump running slower.		
Wall thickness does not match the specifications of the saddle used.	Purchase appropriate saddle or change wall thickness.	
	Discharge pressure too high	Poor flow is caused by excessive backflow, reduce discharge pressure.
		Check pipework dimensions and layout - revise as required.
Tube walks through pump head	Tube outer diameter too small for the pump head used	Adjust tube clamp tension
		Use tube with correct outer diameter.
Premature tube failure	Tube wall thickness does not match the specifications of the rotor assembly.	Purchase appropriate tubing or rotor or change tube wall thickness.
Excessive noise	Tube wall thickness does not match the specifications of the rotor assembly.	Purchase appropriate tubing or rotor or change tube wall thickness.
	Pulsation	Check pipework dimensions & revise as required, eliminate small radius bends

Table 8 Rapide and Rapide 'S' Pump Troubleshooting List

8.1 Pump Malfunctions (*continuous*)

Rapide 5000 Pump Troubleshooting List:

Problem	Cause	Solution
Low Flow / Low Discharge Pressure	Ratio of inner diameter/wall thickness too large for the application (tube too 'soft').	Use thicker wall tube with the same inner diameter. This will require a different rotor assembly.
		Run pump slower with larger inner diameter tube.
		Check pipework dimensions and layout - revise as required.
	Viscosity too high.	Run the pump slower.
		Use thicker wall tube. This will require a different rotor assembly.
		Revise pipework.
	Suction lift too high, resulting in tube not fully returning to fully round.	Use thicker wall tube with the same inner diameter. This will require a different rotor assembly.
		Suction line too long or tube internal diameter too small.
		Revise pipework.
	Tube wall thickness does not match the specifications of the rotor assembly.	Purchase appropriate tubing or rotor assembly or change tube wall thickness.
Discharge pressure too high, causing excessive backflow.	Rotor assembly will discharge more pressure in the clockwise direction.	
	Reduce discharge pressure. Revise pipework.	
Using non-standard tubing.	Use Verderflex approved genuine tubing.	
Tube blockage.	Check tube for obstructions.	
Tube walks through pump head	Tube not installed correctly.	Check installation of tube.
	Tube wall thickness does not match the specifications of the rotor assembly.	Purchase appropriate tubing or rotor or change tube wall thickness.
Premature tube failure	Tube wall thickness does not match the specifications of the rotor assembly.	Purchase appropriate tubing or rotor or change tube wall thickness.
Excessive noise	Tube wall thickness does not match the specifications of the rotor assembly.	Purchase appropriate tubing or rotor or change tube wall thickness.
	Pulsation	Check pipework dimensions and revise as required, eliminate small radius bends.
Tube Burst Not Detected	Contamination of the optical sensor. (if fitted)	Clean contamination from the surface of the tube burst sensor if fitted. (→ <i>Figure 14 Tube Burst Detector</i>)

Table 9 Rapide 5000 Pump Troubleshooting List

9 List of Figures and Tables

9.1 List of Figures

Figure 1	Lifting the Pump	3.1.2
Figure 2	Name Plate	4.2.1
Figure 3	Rapide Exploded View (Generic View)	4.3.1
Figure 4	Rapide 'S' Exploded View (Generic View)	4.3.2
Figure 5	Rapide 5000 Exploded View (Generic View)	4.3.3
Figure 6	Installing the Rotor - Rapide Pump	5.2.1
Figure 7	Installing the Tube - Rapide Pump	5.2.2
Figure 8	Installing the Tube - Rapide 'S' Pump	5.3.1
Figure 9	Tube Clamp Tensioning Screw	5.3.2
Figure 10	Installing a Multi-Channel Pump Head	5.3.3
Figure 11	Installing Continuous Tube - Rapide 5000	5.4.1
Figure 12	Installing the Tube Element - Rapide 5000	5.4.2
Figure 13	Rotor Assembly Replacement - Rapide 5000	5.4.3
Figure 14	Tube Burst Detector - Rapide 5000	7.2.1

9.2 List of Tables

Table 1	Target Groups	1.1
Table 2	Warnings Used in the Manual	1.2
Table 3	Symbols Used in the Manual	1.2
Table 4	Tools Used on the Rapide 5000 Pump	1.3
Table 5	Measures to be Taken if the Pump is Shut Down	6.3
Table 6	Measures Depending on the Behaviour of the Pumped Liquid	6.3
Table 7	Rapide and Maintenance Schedule	7.2.3
Table 8	Rapide and Rapide 'S' Pump Troubleshooting List	8.1
Table 9	Rapide 5000 Pump Troubleshooting List	8.1
Table 10	Declaration of Conformity	10

10 EC Declaration of Conformity



<p>EC declaration of conformity according to machinery directive, appendix II A</p> <p>We, VERDER Ltd., Unit 3 California Drive, Castleford hereby declare that the following machine adheres to the relevant EC directives detailed below</p> <p>Designation Verderflex Rapide Verderflex Rapide 'S' Verderflex Rapide 5000</p> <p>EC directives:</p> <ul style="list-style-type: none"> • Machinery Directive (2006/42/EC) • Low-voltage directive (2014/35/EU) • EMC directive (2014/30/EU) • RoHS Directive (2011/65/EU) and Delegated Directive (EU) 2015/863 <p>Applicable harmonized norms:</p> <ul style="list-style-type: none"> • EN ISO 12100: 2010 		
<p>Manufacturer</p>	VERDER Ltd. Unit 3 California Drive Castleford WF10 5QH UK	
<p>Date: 01/ 10/ 2020</p>	<p>Company stamp / signature:</p>  <p>Anthony Beckwith Head of Development/Construction</p>	<p>Company stamp / signature:</p>  <p>Paul Storr Head of Quality</p>

Table 10 Declaration of Conformity



11 Trademarks

VERDERFLEX® is a registered trademark of Verder International B.V. No permission is granted to use any Verder, trademarks or trade names included in this document without the prior written agreement of Verder International B.V.

Modbus® is a registered trademark of Schneider electric USA, INC.

Profibus® is a registered trademark of PROFIBUS Nutzerorganisation e.V.

Appendix A

1 Technical Specifications

1.1 Pump Specifications – Rapide

Size	Value
Max. delivery pressure	2 bar
Temperature of pumped liquid	Refer datasheet for tube variants
Standard pump operating speeds	68, 93, 137/140 and 196 rpm depending on model
Dimensions	Refer datasheet for models

Table 1 Pump Specifications– Rapide

1.2 Pump Specifications – Rapide ‘S’

Size	Value
Max. delivery pressure	2 bar
Temperature of pumped liquid	Refer datasheet for tube variants
Standard pump operating speeds	60, 113, 151 & 220 rpm depending on model
Dimensions	Refer datasheet for models

Table 2 Pump Specifications– Rapide ‘S’

1.3 Pump Specifications Rapide 5000

Size	Value
Max. delivery pressure	2 bar
Temperature of pumped liquid	Refer datasheet for tube variants
Standard pump operating speeds	45, 134, 179 & 268 rpm depending on model
Dimensions	Refer datasheet for models

Table 3 Pump Specifications– Rapide 5000

1.4 Tube Options

 For safety reasons we do not recommend pumping liquids greater than 80°C (176°F). The following criteria are important when selecting a tube:

- Chemical resistance
- Food grade quality
- Tube life
- Physical compatibility

Type	Feature
Verderprene	General purpose tubing
Silicone	High sterility tubing
Other	Others

Table 4 Verderflex Tube Variants

1.5 Ambient Conditions

 Operation under any other ambient condition would require approval from the manufacturer:

Rapide, Rapide ‘S’ and Rapide 5000:

Operating conditions

- Ambient temperature -5 °C to +45 °C
- Relative humidity – long—term ≤ 85 %
- Setup height above sea level ≤ 1000m / 3000 ft above sea level

Storage conditions

- Ambient temperature +10 °C to +50 °C
- Relative humidity – long—term ≤ 80 %